

CMU - 190mm (8" Inch) Double Face Bullnose

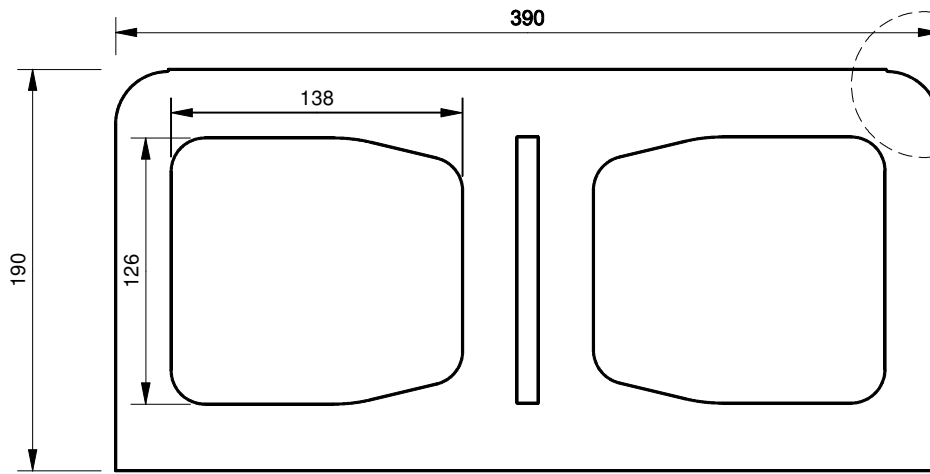

TOP VIEW

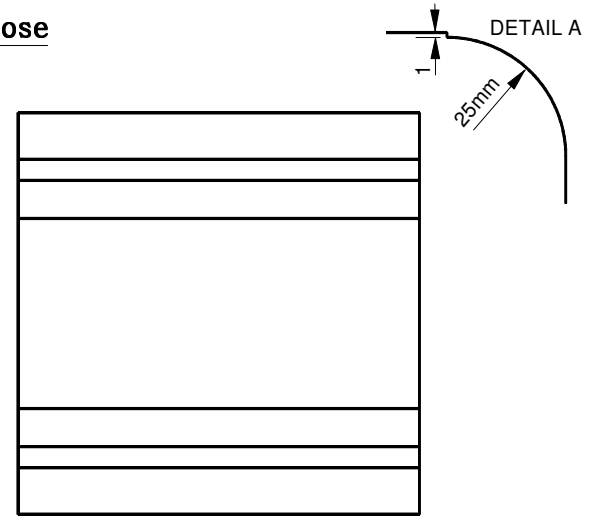

END VIEW

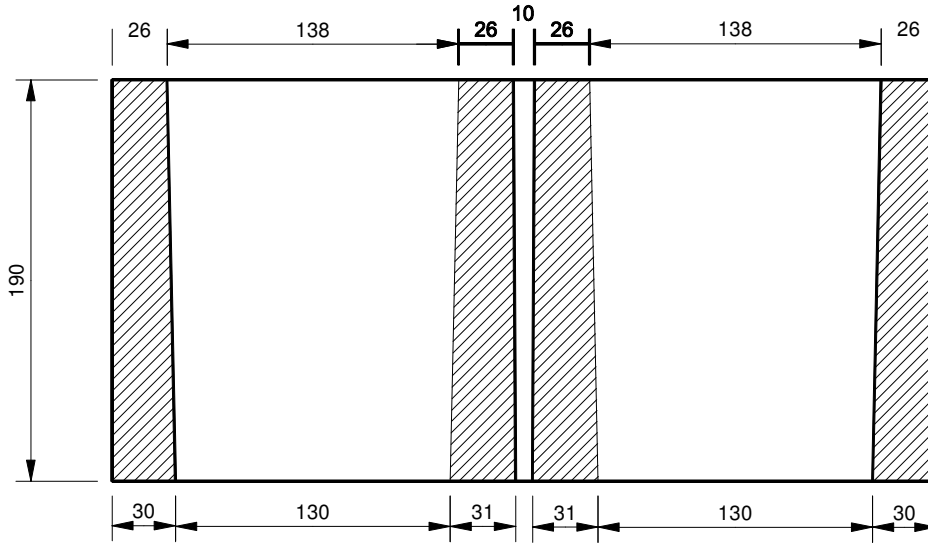

FRONT X-SECTION

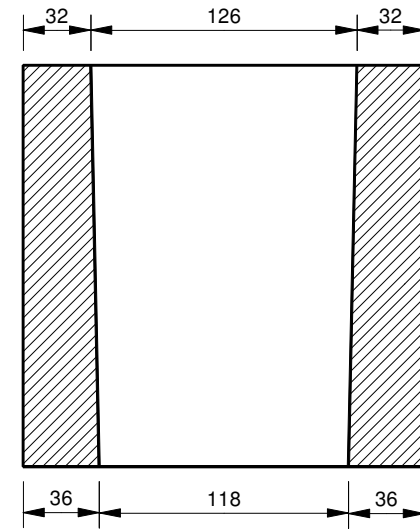

END X-SECTION

NAME: 190x190x390 DOUBLE FACE BULLNOSE

PRODUCER:

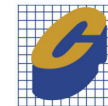

Casey Concrete Ltd.

PACKAGING:
 Pieces Per Pallet: 75
 Weight Per Piece: 19.09 kg (42 lbs)
 Weight Per Pallet: 1432 kg (3150 lbs)
 Coverage Per Piece: 0.8 sq.ft (60 sq.ft per pallet)

DIMENSIONAL TOLERANCES:
 Meets the requirements of CSA A165.1 Concrete Masonry
 LENGTH: -0.12 to +0.12 in (-3 to +3 mm)
 WIDTH: -0.08 to +0.08 in (-2 to +2 mm)
 HEIGHT: -0.12 to +0.08 in (-3 to +2 mm)

PHYSICAL PROPERTIES:
 Meets the requirements of CSA A165.1 Concrete Masonry
 COMPRESSIVE STRENGTH: Min 15MPa @ 28 Days
 ABSORPTION (%) 8.0% Maximum @ 28 Days